

# PD8-6100

ProtEX-MAX Strain Gauge, Load Cell & mV Meter

**ProtEX™**  
MAX



**SUPER-BRIGHT LEDs**  
Our Brightest Display Ever

**MeterView Pro**  
USB Install

**SAFETOUCH®**

IECEX  
FM APPROVED SP Ex CE

**STRAIN GAUGE**

- Modern, Sleek and Practical Enclosure
- Display Mountable at 0°, 90°, 180°, & 270° Degrees
- Explosion-Proof, IP68, NEMA 4X Enclosure
- SunBright Display Standard
- 15, 30, 150, 300 mV Unipolar Input Ranges
- ±15, ±25, ±150, ±250 mV Bipolar Input Ranges
- Isolated 24 VDC @ 25 mA Transmitter Power Supply
- Capture or Programmable Tare Feature
- Auto-Zero Feature Eliminates Zero Drift
- Ratiometric Operation
- Max/Min or Peak/Valley Hold Feature
- Large Dual-Line 6-Digit Display, 0.60" & 0.46"
- Dual-Scale Feature – Single Input
- Rounding Function 1, 2, 5, 10, 20, 50, or 100
- Programmable Display & Function Keys
- 32-Point Linearization
- SafeTouch® Through-Glass Button Programming
- Input Power Options Include 85-265 VAC or 12-24 VDC
- 2 or 4 Relays + Isolated 4-20 mA Output Options
- External 4-Relay & Digital I/O Expansion Modules
- RS-232, & RS-485 Serial Communication Options
- Modbus® RTU Communication Protocol Standard
- Onboard USB and MeterView® Pro Programming Software

**PRECISION  
DIGITAL**

[www.predig.com](http://www.predig.com)

**PRECISION DIGITAL CORPORATION**

# PD8-6100 ProtEX-MAX Strain Gauge, Load Cell & mV Meter

**SafeTouch®** Through-Glass Button Programming



FM APPROVED SP Ex CE IECEx



Sunlight Readable Display



## FEATURE RICH AND FLEXIBLE

The ProtEX-MAX PD8-6100 is a full-featured multipurpose, easy-to-use digital strain gauge & load cell meter ideal for weight and force measurement applications. It is a fully FM, CSA, ATEX, and IECEx approved explosion-proof product. It accepts mV input signals up to 300 mV (unipolar) and ± 250 mV (bipolar). The PD8-6100's powerful dual-scale capability allows the measurement to be displayed in two different units of measure.

## KEY FEATURES

### Precise, Accurate, and More Informative

ProtEX-MAX's large 0.6" upper display provides a highly accurate and precise 6-digit view of the process measurement. Its 24-bit A/D is accurate to ±0.03% of calibrated span ±1 count.



Weight & Units



Net & Gross



mV & Setpoint



Weight & Max (Peak)

## Configurable

The upper display can be programmed to indicate PV, maximum (peak), minimum (valley), alternating maximum/minimum, one of eight alarm set points, or Modbus input. The lower display can also be configured to display engineering units, set points, user defined legends, or simply turned off.

## SafeTouch® Button Programming



The ProtEX-MAX is equipped with four sensors that operate as through-glass buttons so that it can be programmed and operated without removing the cover (and exposing the electronics) in a hazardous area. The SafeTouch buttons are configured by default to duplicate the function of the front panel mechanical pushbuttons associated with the integrated meter.

## Standard SunBright LED Display

The ProtEX-MAX's SunBright display features extraordinarily bright LEDs. They are perfect for indoor and outdoor applications where visibility may be impaired by smoke, fog, dust, or distance or even in direct sunlight.

## Free USB Programming Software & Cable

The ProtEX-MAX™ comes preloaded with free **MeterView® Pro** programming software that connects and installs directly to your PC with a standard USB cable, also provided free with each instrument. This eliminates the need to insert CDs, install drivers, or download software from the internet. The software will allow you to configure, monitor, and datalog a ProtEX-MAX™ PD8-6100 using your PC. Just simply connect the meter to your PC with the USB cable and within minutes you will be programming it.

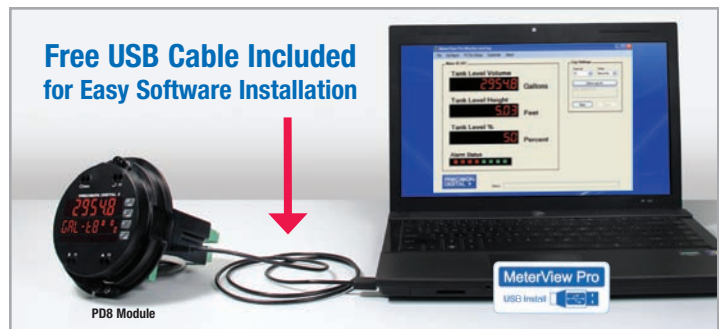

# PD8-6100 ProtEX-MAX Strain Gauge, Load Cell & mV Meter

## Zero the Meter

The zero function zeroes out the display. In the case where there has been drift in the strain gauge output over time, zero is used to eliminate this drift and provide a true zero reading. For example, if an empty scale were to display a value other than zero, the zero function would tell the meter to show zero regardless of the current input signal.

## Capture Tare

The tare function also zeroes out the display. In the case of scale weight, tare is used to eliminate container weight and provide net weight readings. If the tare value is a known constant, such as a container weight, this may be programmed in manually. The captured tare may be reset manually with any function key or digital input.

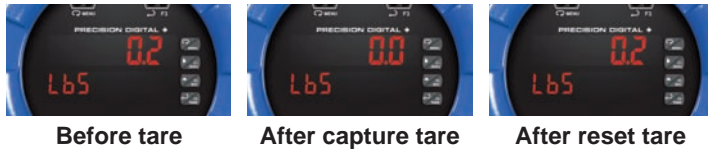

## Automatic Unit Conversion

In addition to entering a custom unit or tag, pre-defined engineering units may be selected: lb, kg, ounce, gram, ton (short), tonne (metric ton). Automatic unit conversions are done when switching between pre-defined units, without the need for additional scaling. The meter converts the reading according to the unit selected (e.g. 100.00 lb = 45.36 kg = 45359.2 g = 1600 oz).

## Auto-Zero

The auto-zero feature corrects for drift that can occur over time that causes the input signal to slowly change. The meter will continue to read zero despite slow and small changes to the input signal around zero. The auto-zero sensitivity is set by the user as a percent of full scale.

## Rounding

The rounding feature is used to give the user a steadier display with fluctuating signals. It causes the display to round to the nearest value according to the rounding value selected (1, 2, 5, 10, 20, 50, or 100). For example, with a rounding value of 10, and an input of 12346, the display would indicate 12350.

## Shunt Calibration Check

The PD8-6100 is equipped with a means of simulating strain in a strain gauge bridge circuit, via an included shunt resistor in the meter. This technique can be used as a means of verifying the meter setup and output behavior by simulating a physical input. With no load connected, the enabling of the shunt resistor will simulate a 70% full scale load in the case of a 350Ω Strain Bridge.

## Ratiometric Compensation

This feature compensates for changes in the strain gauge input signal that are due to variations in the internal or external excitation voltage. The compensation is effective for up to ±5% variation in the excitation power supply.

## Function Keys

There are three function keys available to the user. These keys can be programmed to trigger certain events (e.g. tare the display, reset the tared display, zero the displayed value, acknowledge alarm states, etc.), provide direct menu access points, and more.

## Dual-Scale Display Feature

The ProtEX-MAX PD8-6100 has a rather unique, and very flexible dual-scale capability; a second scaled display can represent the measured input in a different form (i.e. gallons & height). This is of particular value in level applications. Please see the examples shown below. Both displays are independently scaled and are based on the 4-20 mA input signal. Beyond level, this function has been used for pressure & force, weight & piece count, feet & meters, and more.



## Advanced Linearization Capability

The ProtEX-MAX includes a 32-point linearizer. In non-linear level applications (i.e. some pumping or lift stations), it can easily compensate for submerged equipment or plumbing that displace usable volume. A second independent 8-point linearizer is available for a second scaled display (PV2) when the dual scale feature is enabled. Precision Digital's free MeterView Pro PC-based software greatly simplifies the construction of the linearization tables. The software can save this data to the meter and/or PC.

## On-Board Digital Input

The PD8-6100 includes a digital input as a standard feature. This digital input can operate with the tare, reset tare, or interlock relays feature, force relays on from a signal from a PLC or relay on other equipment, and much more. This is ideal for installations where the meter is inaccessible behind a cover, or where an additional function key is needed for customized operation.

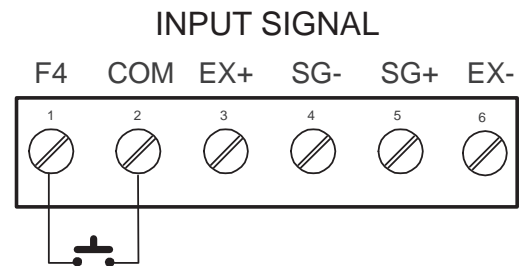

## METERVIEW® PRO SOFTWARE

Configure, monitor, and datalog a ProtEX-MAX PD8-6100 from a PC using MeterView Pro Software available via USB or for download at [www.predig.com](http://www.predig.com).

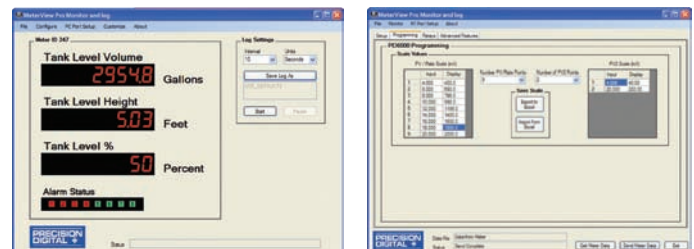



# PD8-6100 ProtEX-MAX Strain Gauge, Load Cell & mV Meter

## APPLICATION

### Load Cell

A typical application for load cells is in a tank weighing operation. In the following example, this three-legged tank has a load cell under each leg. The three load cells are wired locally in parallel within a junction box. The combined signals are then connected to the PD8-6100. During field calibration, the weight of the empty tank (zero point) and the full tank weight (full scale) are programmed into the meter. Over time, the tare feature on the PD8-6100 can account for obstacles like sludge buildup on the bottom of the tank when empty.

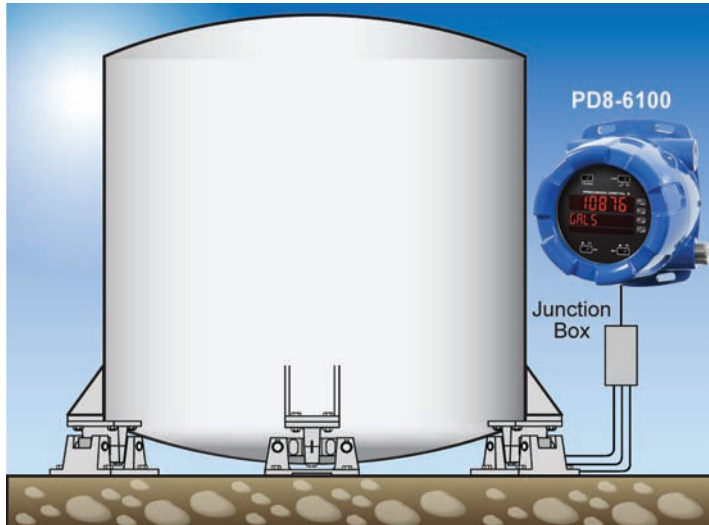

## DIGITAL COMMUNICATIONS

### Modbus® RTU Serial Communications

With the purchase of a serial communication adapter, ProtEX-MAX meters can communicate with any Modbus Master device using the ever-popular Modbus communications protocol that is included in every ProtEX-MAX. This greatly increases the flexibility of the meter. Modbus provides much more capability than read PV and write set points. Below are some examples of other things that can be done with ProtEX-MAX's Modbus communications.

- Send a 6-character message to the lower display upon an event
- Convert a digital value to a 4-20 mA signal
- Remote user control (i.e. change set points, acknowledge alarms)
- Input a Modbus digital PV (in place of analog input)
- Remote override of any, or all, relays and analog outputs



Modbus PV Input



Remote Message

## OUTPUTS

### Relay Outputs

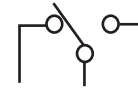

The ProtEX-MAX has up to four 3 A Form C relays (SPDT) with multiple power loss fail-safe options. Relays can be configured for proper protective action upon input loop break. Relay ON and OFF delay times are user adjustable. Up to eight front panel indicators show alarm and/or relay state. All relays can be configured for 0-100% deadband.

### Relay Operation/Configuration

There are powerful relay functions that can be configured in the ProtEX-MAX meter, including:

- Automatic reset only (non-latching)
- Automatic + manual reset at any time (non-latching)
- Latching (manual reset only)
- Latching with clear (manual reset only after alarm condition has cleared)
- Pump alternation control (automatic reset only)
- Sampling (activated for a user-specified time)
- User selectable fail-safe operation
- Relay action for loss (break) of 4-20 mA input signal
- Time delay (on and off), independent for each relay
- Manual control mode
- Interlock relay mode

### Analog Output

The isolated analog retransmission signal can be configured to represent the process variable (PV), maximum (peak) value, minimum (valley) value, the value for any of the eight relay set points, or Modbus input. While the output is nominally 4-20 mA, the signal will accurately accommodate under- and over-ranges from 1 to 23 mA.

### Manual Output Control

Take control of any output with this feature. All relays can be forced ON or OFF, and the 4-20 mA output signal can be set to any value within its range. When the relays and 4-20 mA output are controlled manually, an LED labeled "M" is turned on and the associated Alarm LEDs (1-8) flash every 10 seconds indicating that the meter is in manual control mode.

### Isolated Transmitter Power Supplies

A powerful isolated power supply is a standard feature on the ProtEX-MAX meter. It can be configured for 5, 10 (default), or 24 V (not to be used with strain gauge or load cell) by means of a simple internal jumper (see manual). An additional power supply (24 V @ 25 mA) is standard with the 4-20 mA output option.

## ProtEX VIDEOS

Visit our archive at [predig.com/videos](http://predig.com/videos) to watch a video on the ProtEX-MAX Family of Explosion-Proof Meters. Here, you will also find other videos on the ProtEX Series including videos on loop powered process meters, feet and inches level meters, and flow rate/totalizers. Also, see the SafeTouch through-glass button programming in action.

# PD8-6100 ProtEX-MAX Strain Gauge, Load Cell & mV Meter

## SPECIFICATIONS

Except where noted all specifications apply to operation at +25°C.

### General

**Display:** Upper display: 0.60" (15 mm) high. Lower display: 0.46" (12 mm) high. Both are 6 digits (-99999 to 999999), red LEDs.

**Display Intensity:** Eight intensity levels

**Display Update Rate:** 5/second (200 ms)

**Overrange:** Display flashes 999999

**Underrange:** Display flashes -999999

**Display Assignment:** The displays may be assigned to PV1, PV2, PCT, max & min, set points, PV & units, units (lower display only), net & gross weight, Modbus input, and display millivolts.

**Units:** lb, kg, ounce, gram, ton, metric ton (tonne), custom units.

**Programming Methods:** Four SafeTouch through-glass buttons when cover is installed. Four internal pushbuttons when cover is removed.

**F4 Digital Input Contacts:** 3.3 VDC on contact. Connect normally open contacts across F4 to COM.

**F4 Digital Input Logic Levels:** Logic High: 3 to 5 VDC  
Logic Low: 0 to 1.25 VDC

**Noise Filter:** Programmable from 2 to 199 (0 will disable filter)

**Filter Bypass:** Programmable from 0.1 to 99.9% of calibrated span

**Rounding:** Select 1, 2, 5, 10, 20, 50, or 100 (e.g. rounding = 10, value = 123.45, display = 123.50).

**Recalibration:** All ranges are calibrated at the factory. Recalibration is recommended at least every 12 months.

**Max/Min Display:** Max/min readings reached by the process are stored until reset by the user or until power to the meter is cycled.

**Password:** Three programmable passwords restrict modification of programmed settings.

**Non-Volatile Memory:** All programmed settings are stored in non-volatile memory for a minimum of ten years if power is lost.

**Power Options:** 85-265 VAC 50/60 Hz, 90-265 VDC, 20 W max, or optional model with 12-24 VDC  $\pm 10\%$ , 15 W max.

**Fuse:** Required external fuse: UL Recognized, 5 A max, slow blow; up to 6 meters may share one 5 A fuse.

**Isolated Sensor Power Supply:**  
Terminals Ex+ & Ex-: 10 VDC or 5 VDC  $\pm 10\%$ . Rated @ 25 mA max.  
*Note: Do not use 24 VDC to power strain gauge bridge*

**Normal Mode Rejection:** Greater than 60 dB at 50/60 Hz

**Isolation:** 4 kV input/output-to-power line. 500 V input-to-output (powered by external supply).

**Overvoltage Category:** Installation Overvoltage Category II: Local level with smaller transient overvoltages than Installation Overvoltage Category III.

**Environmental:** T6 Class operating temperature range  $T_a = -40$  to  $60^\circ\text{C}$   
T5 Class operating temperature range  $T_a = -40$  to  $65^\circ\text{C}$

**Max Power Dissipation:** Maximum power dissipation limited to 15.1 W. See PD8-6100 instruction manual for additional details.

**Connections:** Removable screw terminal blocks accept 12 to 22 AWG wire, RJ45 for external relays, digital I/O, and serial communication adapters.

**Enclosure:** Explosion-proof die cast aluminum with glass window, corrosion resistant epoxy coating, color: blue. NEMA 4X, 7, & 9, IP68. Default conduit connections: Four  $\frac{3}{4}$ " NPT threaded conduit openings and two  $\frac{3}{4}$ " NPT metal conduit plugs with 12 mm hex key fitting installed. Additional conduit opening configurations may be available; verify quantity and sizes on specific device labeling during installation.

**Mounting:** Four slotted flanges for wall mounting or NPS  $1\frac{1}{2}$ " to  $2\frac{1}{2}$ " or DN 40 to 65 mm pipe mounting. See Mounting Dimensions in the PD8-6100 instruction manual.

**Dimensions:** 6.42" x 7.97" x 8.47" (W x H x D)  
(163 mm x 202 mm x 215 mm)

**Weight:** 16.0 lbs (7.26 kg)

**Warranty:** 3 years parts & labor

**USB Connection:** Compatibility: USB 2.0 Standard, Compliant  
Connector Type: Micro-B receptacle  
Cable: USB A Male to Micro-B Cable  
Driver: Windows 98/SE, ME, 2000, Server 2003/2008, XP 32/64-Bit, Vista 32/64-Bit, Windows 7 32/64-Bit, Windows 10 32/64-Bit  
Power: USB Port

### Strain Gauge Input

**Inputs:** Field selectable: 0-15, 0-30, 0-150, 0-300 mV,  $\pm 15$ ,  $\pm 25$ ,  $\pm 150$ ,  $\pm 250$  mV, or Modbus PV (Slave)

**Accuracy:**  $\pm 0.03\%$  of calibrated span  $\pm 1$  count

**Temperature Drift:** 0.002% of calibrated span/ $^\circ\text{C}$  max from 0 to  $65^\circ\text{C}$  ambient, 0.005% of calibrated span/ $^\circ\text{C}$  max from  $-30$  to  $0^\circ\text{C}$  ambient

**Function:** Linear with multi-point linearization

**Low-Flow Cutoff:** 0-999999 (0 disables cutoff function)

**Decimal Point:** Up to five decimal places or none: *d.ddddd*, *dd.dddd*, *ddd.ddd*, *dddd.dd*, *ddddd.d*, or *dddddd*.

**Calibration Range:**

Input Range	Minimum Span Input 1 & Input 2
15 mV	0.2 mV
25 mV, 30 mV	0.4 mV
150 mV	2.0 mV
250 mV, 300 mV	4.0 mV

An Error message will appear if the input 1 and input 2 signals are too close together.

**Input Impedance:** Strain Gauge Bridge: Greater than 10 M $\Omega$   
mV Source: 200 k $\Omega$

### Relays

**Rating:** 2 or 4 SPDT (Form C) internal and/or 4 SPST (Form A) external; rated 3 A @ 30 VDC and 125/250 VAC resistive load; 1/14 HP ( $\approx 50$  watts) @ 125/250 VAC for inductive loads.

**Noise Suppression:** Noise suppression is recommended for each relay contact switching inductive loads.

**Deadband:** 0-100% of span, user programmable

**High or Low Alarm:** User may program any alarm for high or low trip point. Unused alarm LEDs and relays may be disabled (turned off).

**Relay Operation:** automatic (non-latching), latching (requires manual acknowledge), sampling (based on time), pump alternation control (2 to 8 relays), Off (disable unused relays and enable interlock feature, manual on/off control mode).

**Relay Reset:** User selectable via front panel buttons or digital inputs.

1. Automatic reset only (non-latching), when input passes the reset point.
2. Automatic + manual reset at any time (non-latching).
3. Manual reset only, at any time (latching).
4. Manual reset only after alarm condition has cleared (latching).

*Note: Front panel button or digital input may be assigned to acknowledge relays programmed for manual reset.*

**Time Delay:** 0 to 999.9 seconds, on & off relay time delays. Programmable and independent for each relay.

**Fail-Safe Operation:** Programmable and independent for each relay.  
*Note: Relay coil is energized in non-alarm condition. In case of power failure, relay will go to alarm state.*

**Auto Initialization:** When power is applied to the meter, relays will reflect the state of the input to the meter.

### Serial Communications

**Protocol:** Modbus<sup>®</sup> RTU

**Slave ID:** 1 - 247 (Meter address)

**Baud Rate:** 300 - 19,200 bps

**Transmit Time Delay:** Programmable between 0 and 199 ms or transmitter always on for RS-422 communication

**Data:** 8 bit (1 start bit, 1 or 2 stop bits)

**Parity:** Even, odd, or none with 1 or 2 stop bits

**Byte-to-Byte Timeout:** 0.01 - 2.54 seconds

**Turn Around Delay:** Less than 2 ms (fixed)

*Note: Refer to the ProVu<sup>®</sup> Modbus Register Tables located at [www.predig.com](http://www.predig.com) for details.*

# PD8-6100 ProtEX-MAX Strain Gauge, Load Cell & mV Meter

## Isolated 4-20 mA Transmitter Output

**Output Source:** Process variable (PV), max, min, set points 1-8, manual control setting, or Modbus input

**Scaling Range:** 1.000 to 23.000 mA for any display range

**Calibration:** Factory calibrated: 0.00 to 100.0 = 4-20 mA output

**Analog Output Programming:** 1.000 mA minimum and 23.000 mA maximum for all parameters: Overrange, underrange, max, min, and break

**Accuracy:**  $\pm 0.1\%$  of span  $\pm 0.004$  mA

**Temperature Drift:** 0.4  $\mu\text{A}/^\circ\text{C}$  max from 0 to 65°C ambient, 0.8  $\mu\text{A}/^\circ\text{C}$  max from -40 to 0°C ambient

*Note: Analog output drift is separate from input drift.*

**Isolated Transmitter Power Supply:** Terminals I+ & R: 24 VDC  $\pm 10\%$ . Isolated from the input at >500 V. May be used to power the 4-20 mA output or other devices (except load cell/strain gauge). All models @ 25 mA max.

**External Loop Power Supply:** 35 VDC maximum

**Output Loop Resistance:**

Power supply	Minimum	Maximum
24 VDC	10 $\Omega$	700 $\Omega$
35 VDC (external)	100 $\Omega$	1200 $\Omega$

## Product Ratings and Approvals

**FM:** Type 4X; IP66

Class I, Division 1, Groups B, C, D

Class II, Division 1, Groups E, F, G

Class III, Division 1, T5/T6

Class I, Zone 1, AEx d, IIC Gb T5/T6

Zone 21, AEx tb IIIC T90°C; Ta -40°C to +65°C

T6 Ta = -40°C to +60°C; T5 Ta = -40°C to +65°C

Certificate Number: 3047283

**CSA:** Class I, Division 1, Groups B, C, D

Class II, Division 1, Groups E, F, G

Class III, Division 1

Class I Zone 1 Ex d IIC

Zone 21 Ex tb IIIC T90°C

-40°C < Tamb. < +60°C; Temperature Code T6

-40°C < Tamb. < +65°C; Temperature Code T5

Enclosure Type 4X & IP66

Certificate Number: 2531731

**ATEX:** II 2 G D

Ex d IIC T\* Gb

Ex tb IIIC T90°C Db IP68

Ta = -40°C to +\*°C

\*T6 = -40°C to +60°C

\*T5 = -40°C to +65°C

Certificate number: Sira 12ATEX1182

**IECEX:** Ex d IIC T\* Gb

Ex tb IIIC T90°C Db IP68

Ta = -40°C to +\*°C

\*T6 = -40°C to +60°C

\*T5 = -40°C to +65°C

Certificate Number: IECEX SIR 12.0073

## DIMENSIONS

Units: Inches (mm)

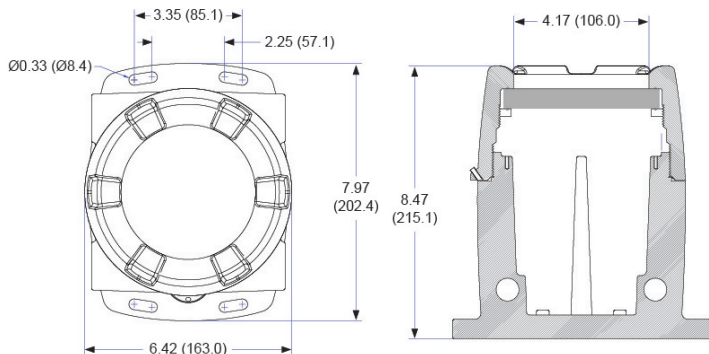

## CONNECTIONS

- Form C (SPDT) relays
- Two isolated supplies available even on 12-24 VDC input power models
- Removable terminal blocks
- 2 or 4 relays + isolated 4-20 mA output option

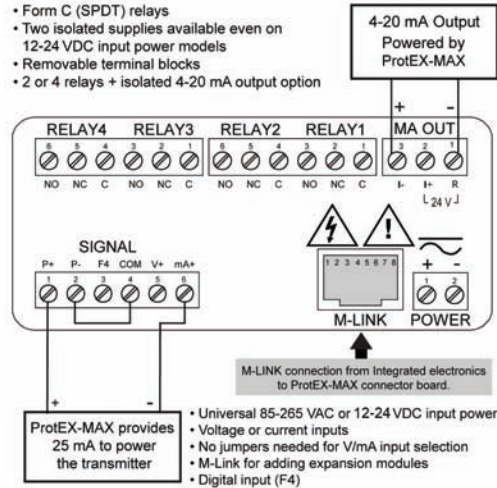

## ORDERING INFORMATION

ProtEX-MAX® PD8-6100 Models		
85-265 VAC Model	12-24 VDC Model	Options Installed
PD8-6100-6H0	PD8-6100-7H0	None
PD8-6100-6H2	PD8-6100-7H2	2 Relays
PD8-6100-6H3	PD8-6100-7H3	4-20 mA Output
PD8-6100-6H4	PD8-6100-7H4	4 Relays
PD8-6100-6H5	PD8-6100-7H5	2 Relays & 4-20 mA Output
PD8-6100-6H7	PD8-6100-7H7	4 Relays & 4-20 mA Output

Note: 24 V Transmitter power supply standard on all models.

Accessories	
Model	Description
PDAPLUG75	3/4" NPT 316 Stainless Steel Stopping Plug with Approvals
PDA7485-I	RS-232 to RS-422/485 Isolated Converter
PDA7485-N	RS-232 to RS-422/485 Non-Isolated Converter
PDA8485-I	USB to RS-422/485 Isolated Converter
PDA8485-N	USB to RS-422/485 Non-Isolated Converter
PDA6846	Pipe Mounting Kit Zinc Plated (Requires 2)
PDA6846-SS	Pipe Mounting Kit Stainless Steel (Requires 2)

Your Local Distributor is:

## Disclaimer

The information contained in this document is subject to change without notice. Precision Digital Corporation makes no representations or warranties with respect to the contents hereof, and specifically disclaims any implied warranties of merchantability or fitness for a particular purpose. ©2016-2017 Precision Digital Corporation. All rights reserved.

LDS8-6100\_C 06/17

**PRECISION DIGITAL CORPORATION**

233 South Street • Hopkinton MA 01748 USA • Tel (800) 343-1001 • Fax (508) 655-8990

**PRECISION DIGITAL**  
www.predig.com