

FS-925E 0.4 - 6.0 (l/min) with pre-adjusted set points
 FS-926E 0.05 - 0.3 (l/min) with pre-adjusted set points

PISTON TYPE

These two series of precision-calibrated switches provides reliable and consistent performance; repeatability is within 1%. FS-925E and FS-926E units are factory preset for actuation at specified flow rates.

These switches provide accurate detection of excessive or insufficient flow rates in such applications as: protecting against loss of fluid flow in hydraulic systems, assuring proper coolant flow in semiconductor processing equipment, monitoring high pressure lubrication systems, and ensuring proper air flow in water/waste systems.

Specifications

(all data related to water at +20°C)

	FS-925E	FS-926E
Max. flow	12 l/min	3 l/min
Max. operating pressure	68 bar	68 bar
Proof pressure	100 bar	100 bar
Temperature range	- with Polysulfone piston (standard), with cable, with plug connector: -20 °C...+80 °C - with metal piston and terminal box: -20 °C...+150 °C	
Set points (l/min)	0.4; 1.0; 2.0; 3.0; 4.0; 6.0	0.05, 0.1, 0.15; 0.1; 0.25; 0.3
Switching function (related to increasing flow)	NC, NO, SPDT	NC, NO, SPDT
Mounting orientation	any position	any position
Factory calibration position with set point adjustment	vertical, inlet port down, electrical connection up	
Repeatability	± 1%	± 1%
Adjustment accuracy	±10%	±10%
Hysteresis	max. 15%	max. 20%
Mounting	G 1/4"	G 1/4"
Electrical connections	- cable: PVC, 2 or 3 x 0.34 mm ² (length: approx. 1 m) - plug connector per DIN 43650 - terminal box	
Enclosure	- IP 65	IP 65
Electrical data contact rating	- SPST (NC/NO): max. 100 VA, 3 A, 220 V~ - SPDT: max. 20 VA, 0.5 A, 250 V~	
Weight	0.5 kg	0.5 kg

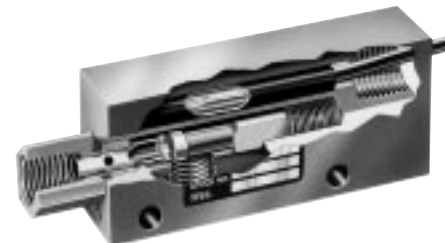
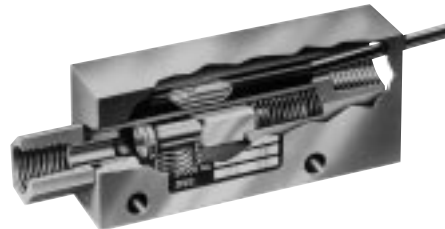

Dimensions (in mm)

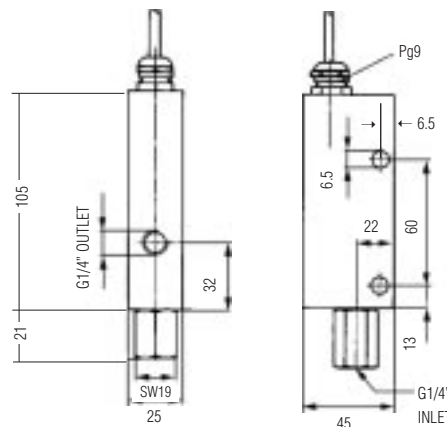

Housing: Brass or Stainless Steel
 Piston: Polysulfone* or Stainless Steel (* option Brass)
 Spring: Stainless Steel
 O-Ring: Vitton®

Terminal Box

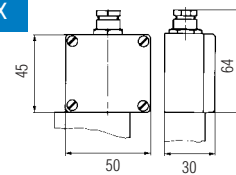

Plug Connector

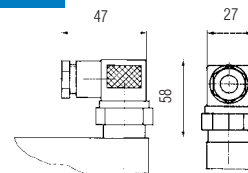

How to Order for FS-925E / FS-926E

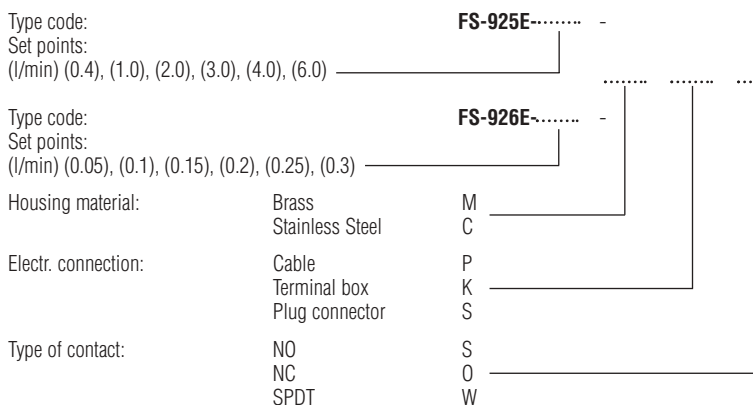

Note: For mineral oil applications please order brass piston instead of polysulfone piston, -GE169 to the number e.g. FS-925E-0.4-M-P-W-GE169

Pressure Drop Diagram

(at min. set point adjustment)

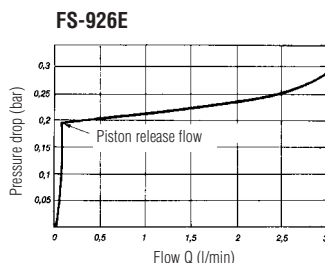
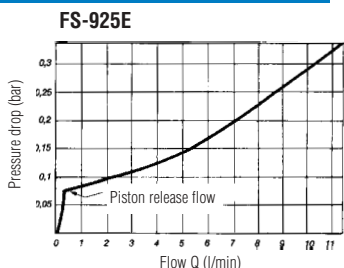

Wiring Diagram

